

H.1000 mm. Art. 11.001 Ø 14 circa
 H.1000 mm. Art. 11.001.01 Ø 14 circa
 H.1000 mm. Art. 11.002.P □ 14 mm
 H.1000 mm. Art. 11.002 □ 14 circa
 Art. 11.002.E □ 10 circa
 Art. 11.002.D □ 12 circa
 H.1000 mm. Art. 11.003 □ 14 circa
 Art. 11.003.E □ 10 circa
 Art. 11.003.D □ 12 circa
 Rastremato / Tapered H.1000 mm. Art. 11.003.01.P Ø 14 mm
 H.1000 mm. Art. 11.003.01 Ø 14 circa
 Art. 11.003.01.E Ø 12 circa
 H.1000 mm. Art. 11.003.02 Ø 14 circa
 Art. 11.003.02.E Ø 12 circa
 H.1000 mm. Art. 11.003.03 Ø 14 mm
 H.1000 mm. Art. 11.003.04 Ø 14 mm
 H.1000 mm. Art. 11.004 □ 14 circa

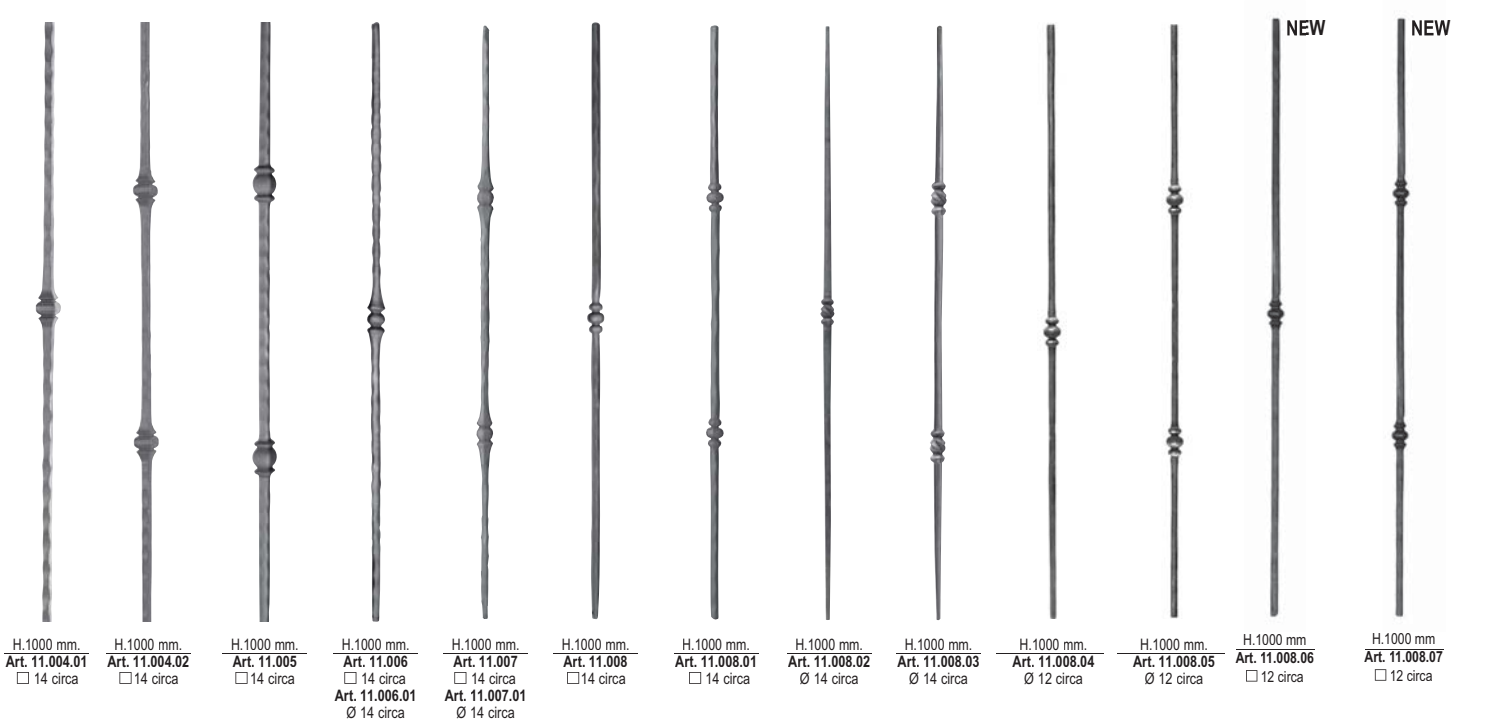

H.1000 mm. Art. 11.004.01 □ 14 circa
 H.1000 mm. Art. 11.004.02 □ 14 circa
 H.1000 mm. Art. 11.005 □ 14 circa
 H.1000 mm. Art. 11.006 □ 14 circa
 Art. 11.006.01 Ø 14 circa
 H.1000 mm. Art. 11.007 □ 14 circa
 Art. 11.007.01 Ø 14 circa
 H.1000 mm. Art. 11.008 □ 14 circa
 H.1000 mm. Art. 11.008.01 □ 14 circa
 H.1000 mm. Art. 11.008.02 Ø 14 circa
 H.1000 mm. Art. 11.008.03 Ø 14 circa
 H.1000 mm. Art. 11.008.04 Ø 12 circa
 H.1000 mm. Art. 11.008.05 Ø 12 circa
 H.1000 mm. Art. 11.008.06 □ 12 circa
 H.1000 mm. Art. 11.008.07 □ 12 circa

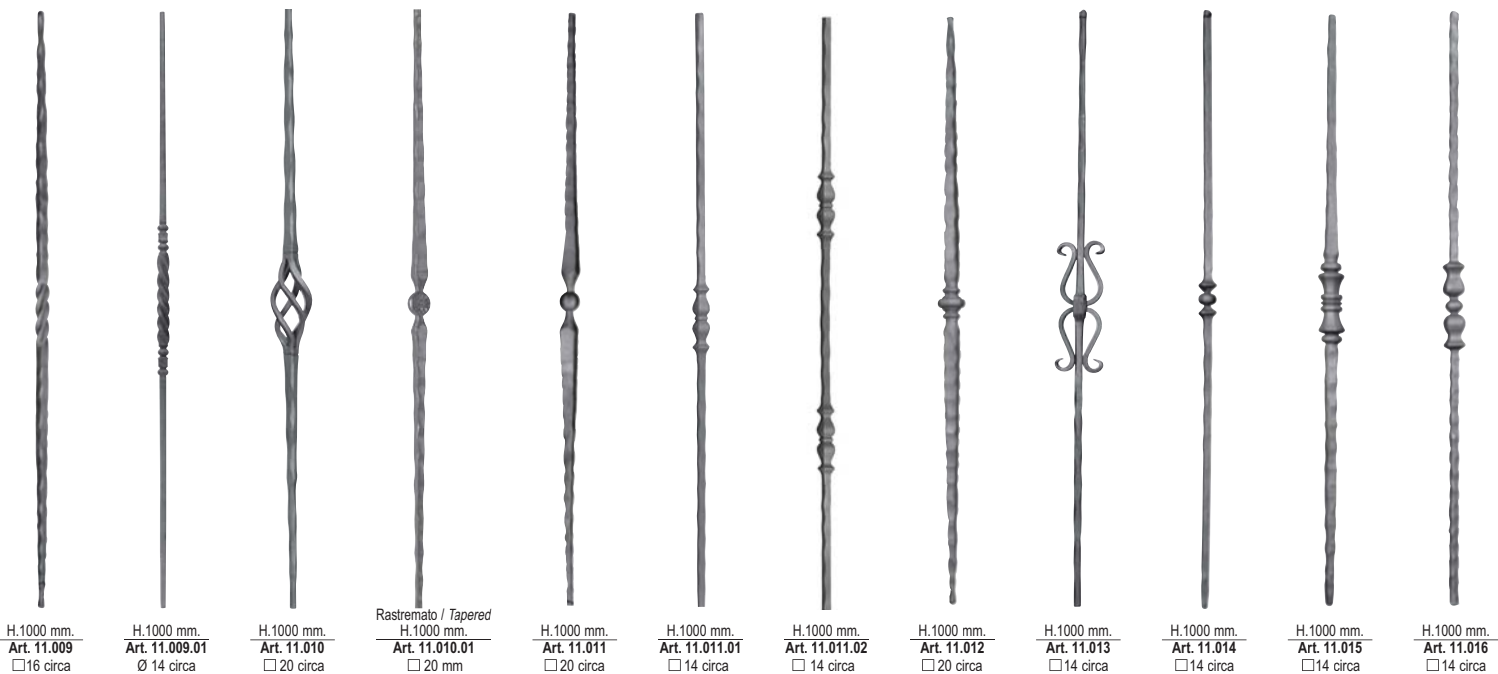

H.1000 mm. Art. 11.009 □ 16 circa
 H.1000 mm. Art. 11.009.01 Ø 14 circa
 H.1000 mm. Art. 11.010 □ 20 circa
 Rastremato / Tapered H.1000 mm. Art. 11.010.01 □ 20 mm
 H.1000 mm. Art. 11.011 □ 20 circa
 H.1000 mm. Art. 11.011.01 □ 14 circa
 H.1000 mm. Art. 11.011.02 □ 14 circa
 H.1000 mm. Art. 11.012 □ 20 circa
 H.1000 mm. Art. 11.013 □ 14 circa
 H.1000 mm. Art. 11.014 □ 14 circa
 H.1000 mm. Art. 11.015 □ 14 circa
 H.1000 mm. Art. 11.016 □ 14 circa

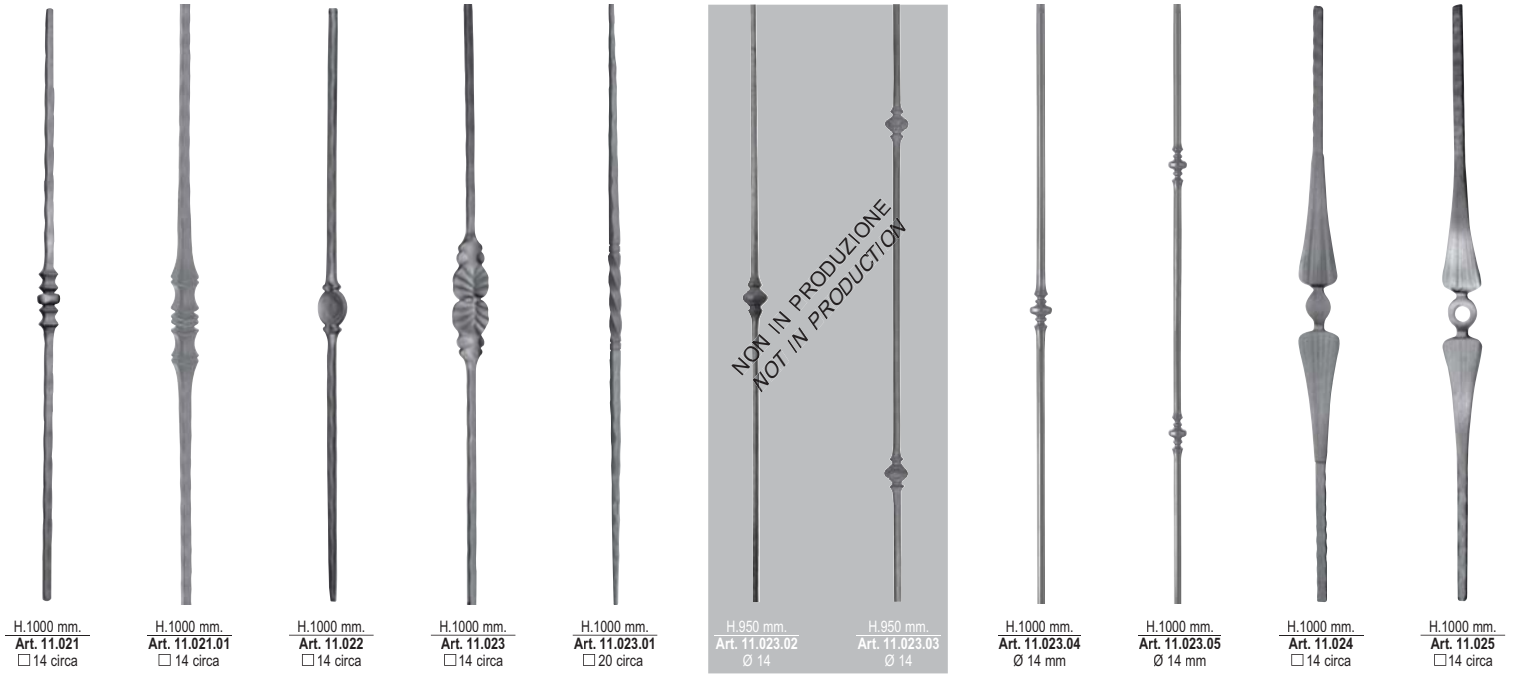
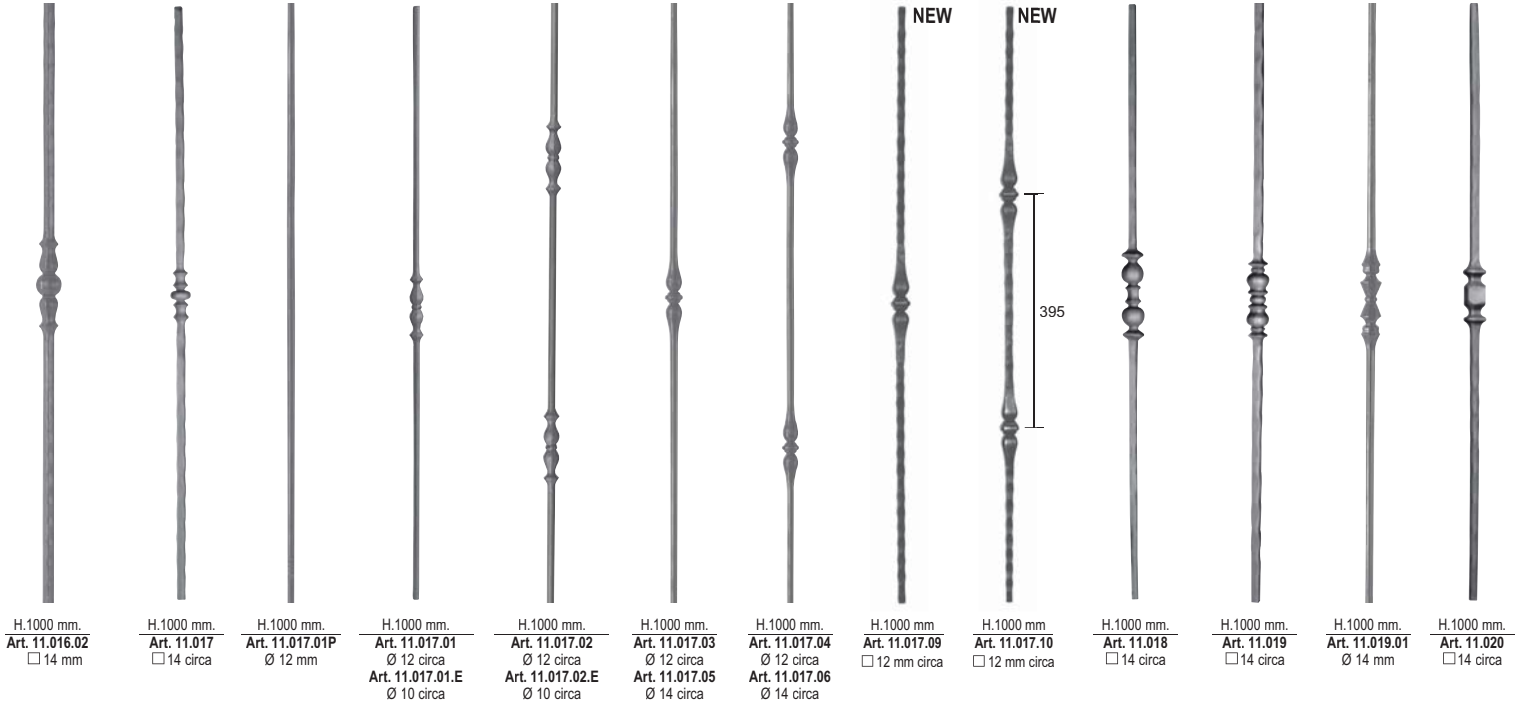

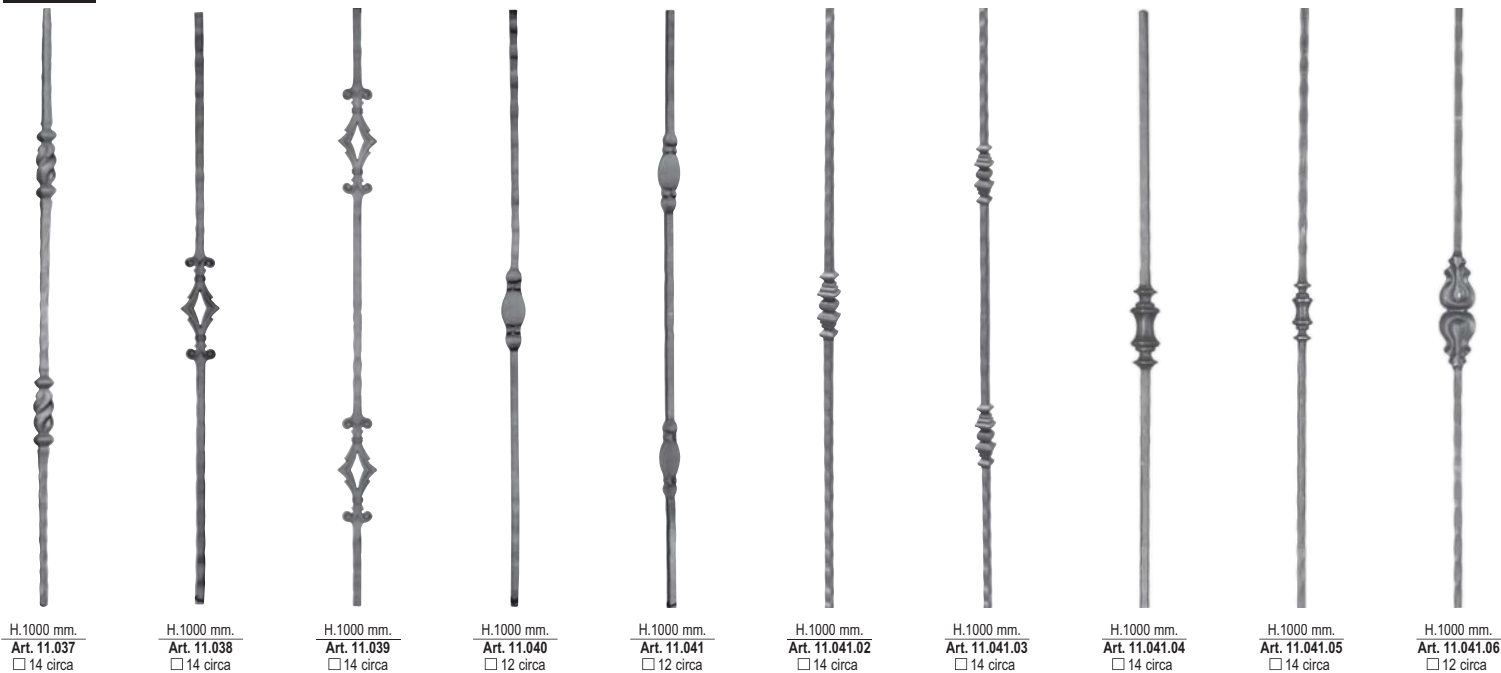

PALLINE PICCOLE / SMALL BALLS



PALLINE PICCOLE / SMALL BALLS



PALLINE PICCOLE / SMALL BALLS



H.1000 mm.
Art. 11.041.29 □ 14 circa

H.1000 mm.
Art. 11.041.30 □ 14 circa

H.1000 mm.
Art. 11.041.31 □ 14 circa

H.1000 mm.
Art. 11.041.32 □ 14 circa



PARTICOLARE

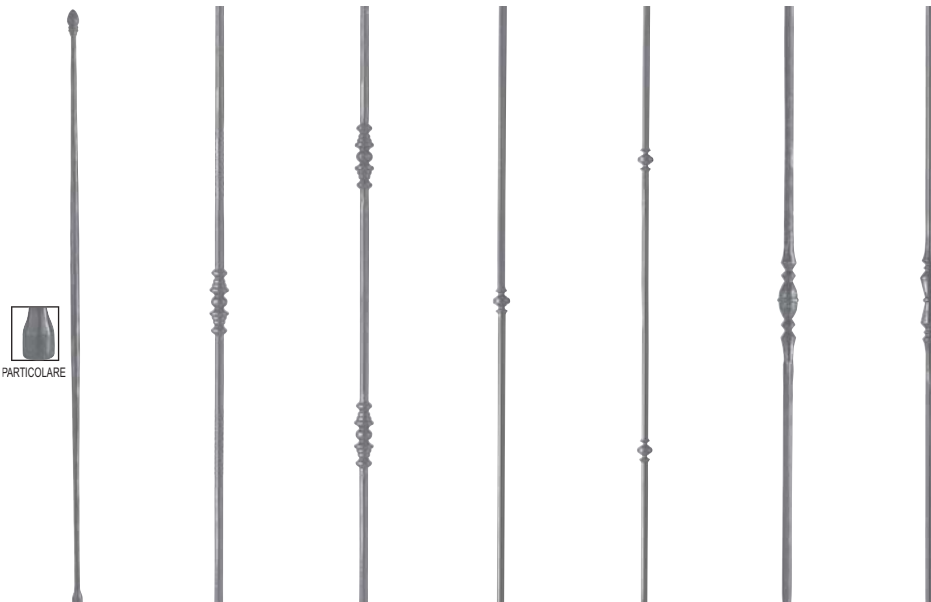

H.1000 mm.
Art. 11.041.33 Ø 14 circa

H.1000 mm.
Art. 11.041.34 Ø 14 mm

H.1000 mm.
Art. 11.041.35 Ø 14 mm

H.1000 mm.
Art. 11.041.36 Ø 12 mm

H.1000 mm.
Art. 11.041.37 Ø 12 mm

H.1000 mm.
Art. 11.041.38 □ 14 circa

H.1000 mm.
Art. 11.041.39 Ø 12 mm

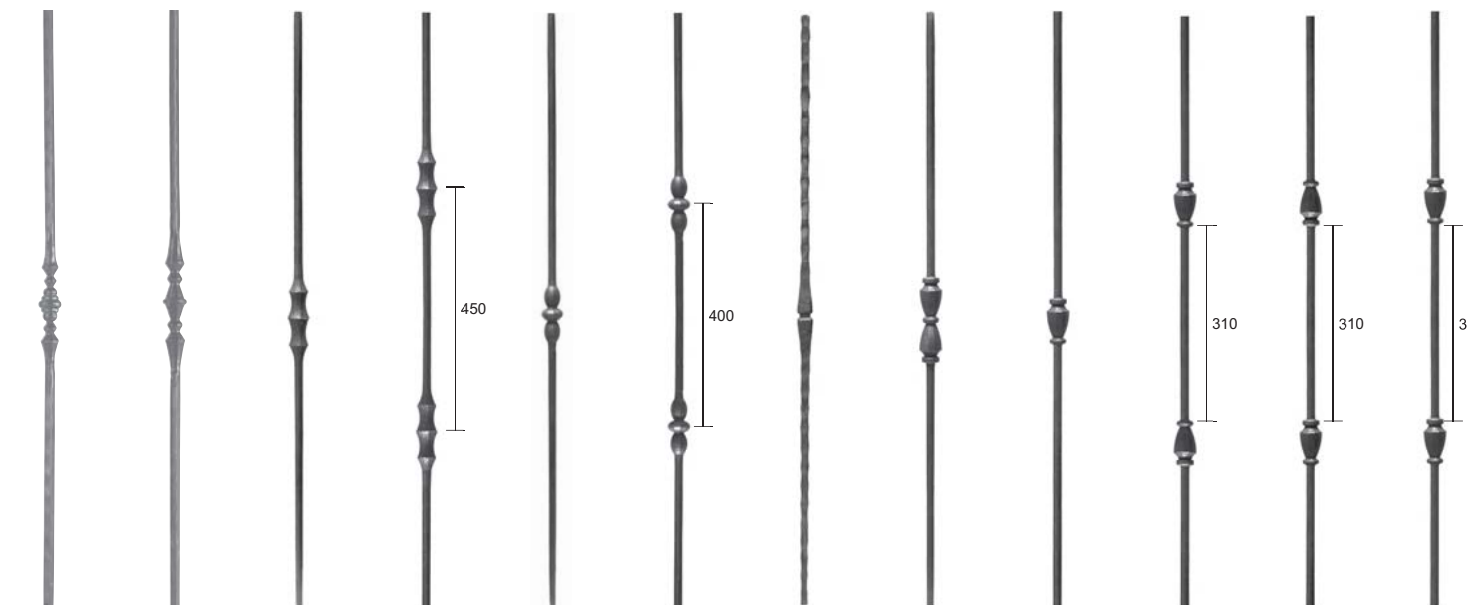

H.1000 mm.
Art. 11.041.40 □ 14 mm

H.1000 mm.
Art. 11.041.41 □ 14 mm

H.1000 mm.
Art. 11.041.42 Ø 14 mm circa

H.1000 mm.
Art. 11.041.43 Ø 14 mm circa

H.1000 mm.
Art. 11.041.44 Ø 14 mm circa

H.1000 mm.
Art. 11.041.45 Ø 14 mm circa

H.1000 mm.
Art. 11.041.46 □ 14 mm circa

H.1000 mm.
Art. 11.041.47 Ø 14 mm circa

H.1000 mm.
Art. 11.041.48 Ø 14 mm circa

H.1000 mm.
Art. 11.041.49 Ø 14 mm circa

H.1000 mm.
Art. 11.041.50 Ø 14 mm circa

H.1000 mm.
Art. 11.041.51 Ø 14 mm circa

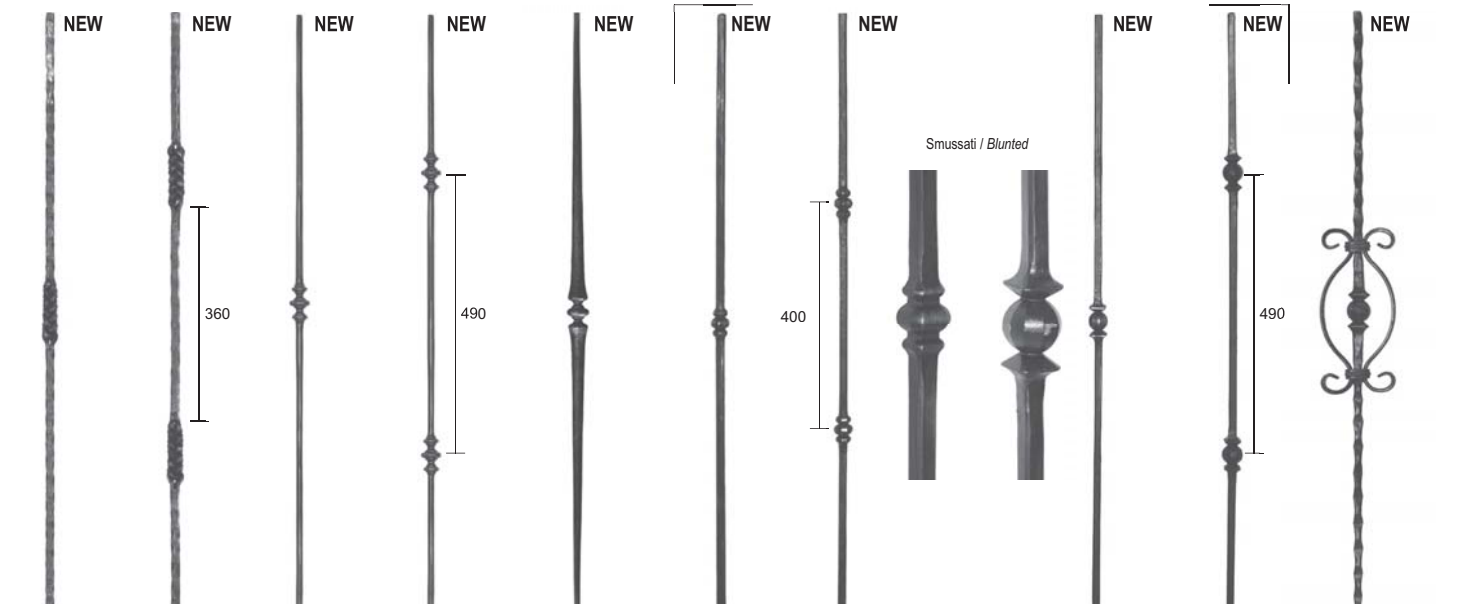

H.1000 mm.
Art. 11.041.52 Ø 12 mm ca.

H.1000 mm.
Art. 11.041.53 Ø 12 mm ca.

H.1000 mm.
Art. 11.041.54 Ø 12 mm ca.

H.1000 mm.
Art. 11.041.55 Ø 12 mm ca.

H.1000 mm.
Art. 11.041.68 Ø 12 ca.

H.1000 mm.
Art. 11.041.69 Ø 14 ca.

H.1000 mm.
Art. 11.041.70 □ 14 mm ca.

H.1000 mm.
Art. 11.041.71 □ 14 mm ca.

H.1000 mm.
Art. 11.041.72 □ 12 mm ca.

H.1000 mm.
Art. 11.041.73 □ 12 mm ca.

H.1000 x L.120 mm
Art. 11.041.79 □ 14 mm ca.

Smussati / Blunted

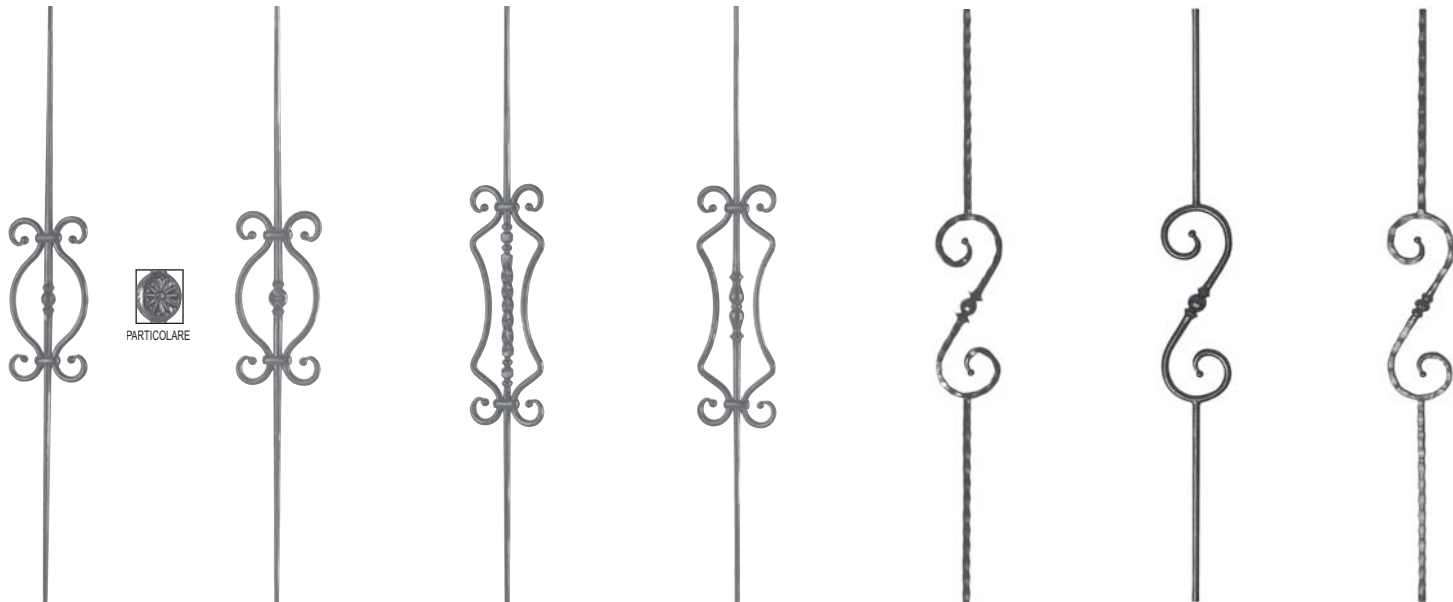

H.1000 X L.135 mm
Art. 11.041.80
Ø 14 mm

H.1000 X L.135 mm
Art. 11.041.81
Ø 14 mm

H.1000 X L.135 mm.
Art. 11.041.82
Ø 14 mm

H.1000 X L.135 mm.
Art. 11.041.83
Ø 12 mm

H.1000 X L.125 mm.
Art. 11.041.84
□ 14 mm circa

H.1000 X L.125 mm.
Art. 11.041.85
Ø 14 mm circa

H.1000 X L.125 mm.
Art. 11.041.86
□ 14 mm circa

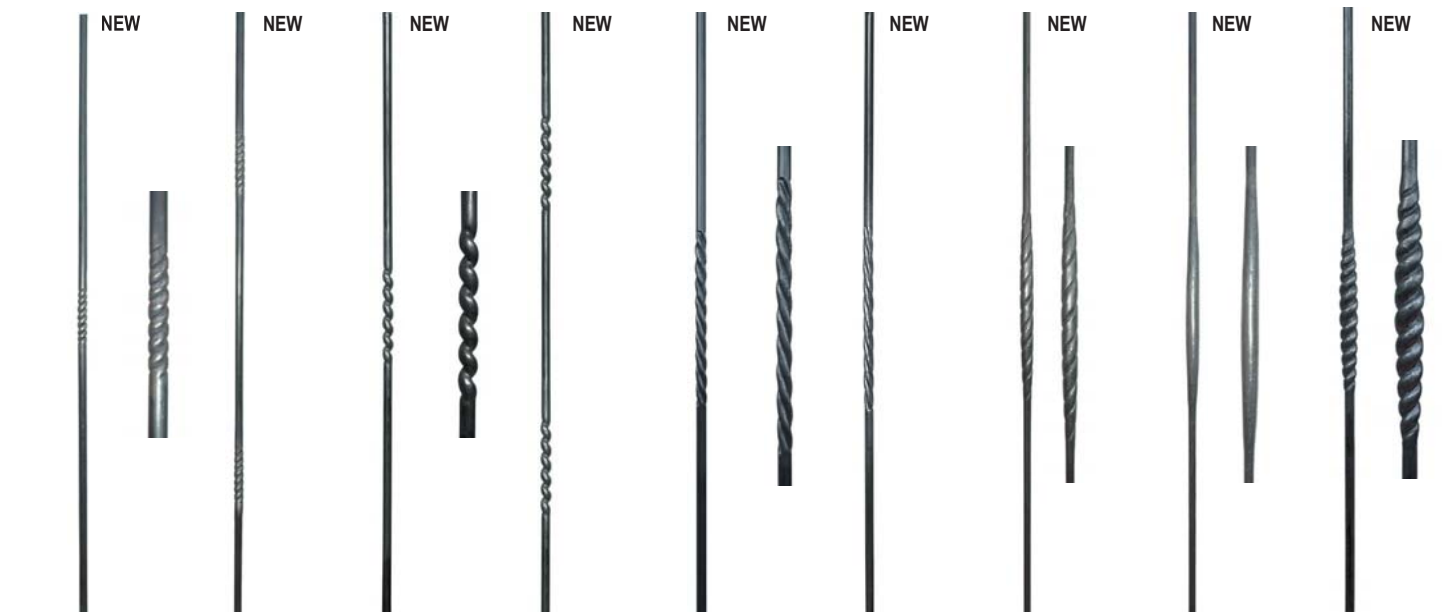

Liscio / Smooth
H.1000 mm
Art. 11.041.100 Ø12 ca.
Art. 11.041.101 Ø14 ca.

Liscio / Smooth
H.1000 mm
Art. 11.041.102 Ø12 ca.
Art. 11.041.103 Ø14 ca.

Liscio / Smooth
H.1000 mm
Art. 11.041.104 Ø14 ca.

Liscio / Smooth
H.1000 mm
Art. 11.041.105 Ø14 ca.

Liscio / Smooth
H.1000 mm
Art. 11.041.106 Ø 12 ca.

Liscio / Smooth
H.1000 mm
Art. 11.041.107 Ø 14 ca.

Forgiato / Forged
H.1000 mm
Art. 11.041.108 Ø 12 ca.

Forgiato / Forged
H.1000 mm
Art. 11.041.109 Ø 12 ca.

Forgiato / Forged
H.1000 mm
Art. 11.041.110 Ø 12 ca.

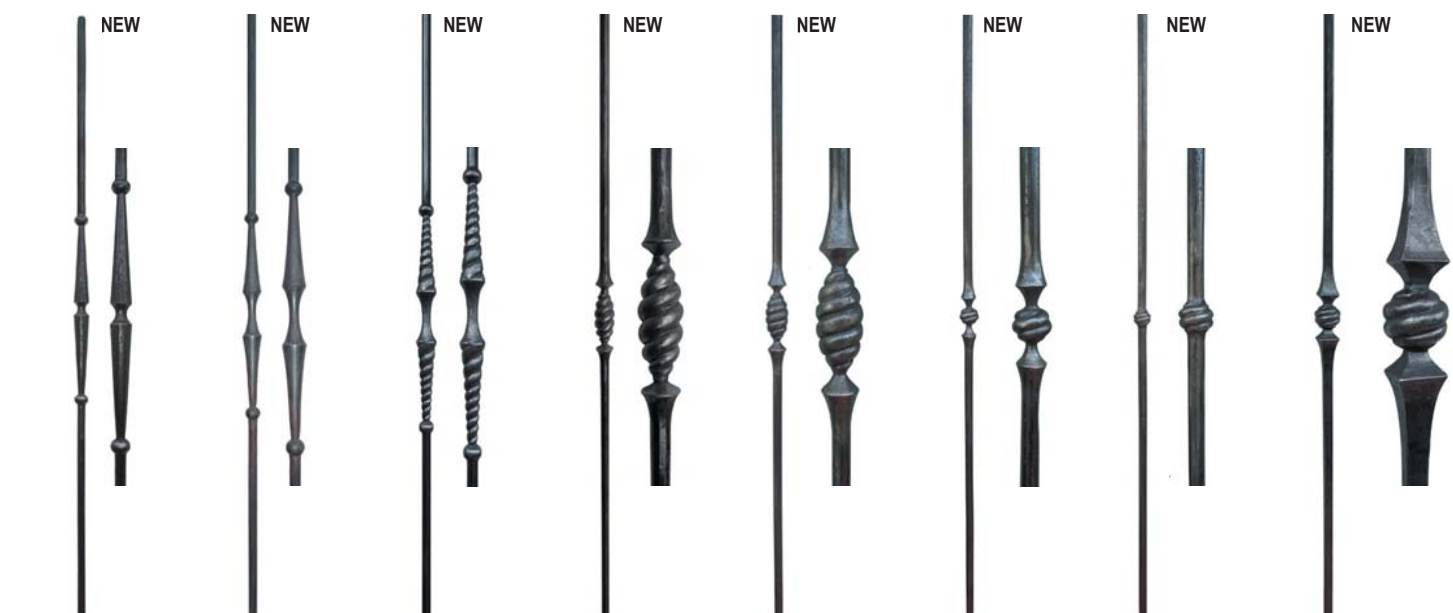

Forgiato / Forged
H.1000 mm
Art. 11.041.111 Ø12 ca.

Forgiato / Forged
H.1000 mm
Art. 11.041.112 Ø12 ca.

Forgiato / Forged
H.1000 mm
Art. 11.041.113 Ø12 ca.

Forgiato / Forged
H.1000 mm
Art. 11.041.114 Ø12 ca.









Forgiato / Forged
H.1000 mm
Art. 11.041.115 Ø14 ca.











Forgiato / Forged
H.1000 mm
Art. 11.041.116 Ø12 ca.









Forgiato / Forged
H.1000 mm
Art. 11.041.117 Ø12 ca.

Forgiato / Forged
H.1000 mm
Art. 11.041.117 Ø12 ca.

Smussato / Blunted
H.1000 mm
Art. 11.041.118 Ø13 ca.

										
Battuto / Beaten H.1100 mm.	H.1100 mm.	H.1100 mm.	H.1200 mm.	In Spigolo / Edged Bar H.1200 mm.	H.1100 mm.	Martellato / Hammered H.1100 mm.	Liscio / Smooth H.1200 mm	Liscio / Smooth H.1200 mm	Liscio / Smooth H.1200 mm	In Spigolo / Edged Bar H.1200 mm.
Art. 11.042 □ 20 Art. 11.043 □ 25 Art. 11.044 □ 30	Art. 11.044.01 □ 20 Art. 11.044.02 □ 25 Art. 11.044.03 □ 30	Art. 11.044.04 □ 20 Art. 11.044.05 □ 25 Art. 11.044.06 □ 30	Art. 11.044.07 □ 20 Art. 11.044.08 □ 25 Art. 11.044.09 □ 30	Art. 11.045 □ 25 Art. 11.046 □ 30	Art. 11.047 □ 20 Art. 11.048 □ 25 Art. 11.049 □ 30	Art. 11.049.01 □ 20 Art. 11.049.02 □ 25 Art. 11.049.03 □ 30	Art. 11.049.08 Ø 25 circa	Art. 11.049.09 Ø 25 circa	Art. 11.049.10 Ø 25 circa	Art. 11.050 □ 25 Art. 11.051 □ 30

									
Martellato / Hammered H.1100 mm.	H.1100 mm.	H.1200 mm.	H.1200 mm.	Martellato / Hammered H.1200 mm.	Tondo / Round H.1200 mm.	H.1200 mm.	Martellato / Hammered H.1200 mm.	Tondo / Round H.1200 mm.	H.1200 mm.
Art. 11.052 □ 20 Art. 11.052.01 □ 25 Art. 11.052.02 □ 30	Art. 11.053 □ 20 Art. 11.053.01 □ 25 Art. 11.053.02 □ 30	Art. 11.053.03 □ 25 Art. 11.053.04 □ 30	Art. 11.053.05 □ 25 Art. 11.053.06 □ 30	Art. 11.053.07 □ 25 Art. 11.053.08 □ 30	Art. 11.053.09 Ø 25 Art. 11.053.10 Ø 30	Art. 11.053.11 □ 25 Art. 11.053.12 □ 30	Art. 11.053.13 □ 25 Art. 11.053.14 □ 30	Art. 11.053.15 Ø 25 Art. 11.053.16 Ø 30	Art. 11.053.17 □ 20 Art. 11.053.18 □ 25 Art. 11.053.19 □ 30

								
Martellato / Hammered H.1200 mm.	Tondo / Round H.1200 mm.	H.1200 mm.	Martellato / Hammered H.1200 mm.	Tondo / Round H.1200 mm.	Tondo / Round H.1200 mm.	H.1200 mm.	H.1200 mm.	H.1200 mm.
Art. 11.053.20 □ 20 Art. 11.053.21 □ 25 Art. 11.053.22 □ 30	Art. 11.053.23 Ø 25 Art. 11.053.24 Ø 30	Art. 11.053.25 □ 25 Art. 11.053.26 □ 30	Art. 11.053.27 □ 25 Art. 11.053.28 □ 30	Art. 11.053.29 Ø 25	Art. 11.053.30 Ø 25	Art. 11.053.31 □ 25 Art. 11.053.32 □ 30	Art. 11.053.33 □ 25 Art. 11.053.34 □ 30	Art. 11.053.35 □ 25 Art. 11.053.36 □ 30

Borchia Tornita
Turned Stud

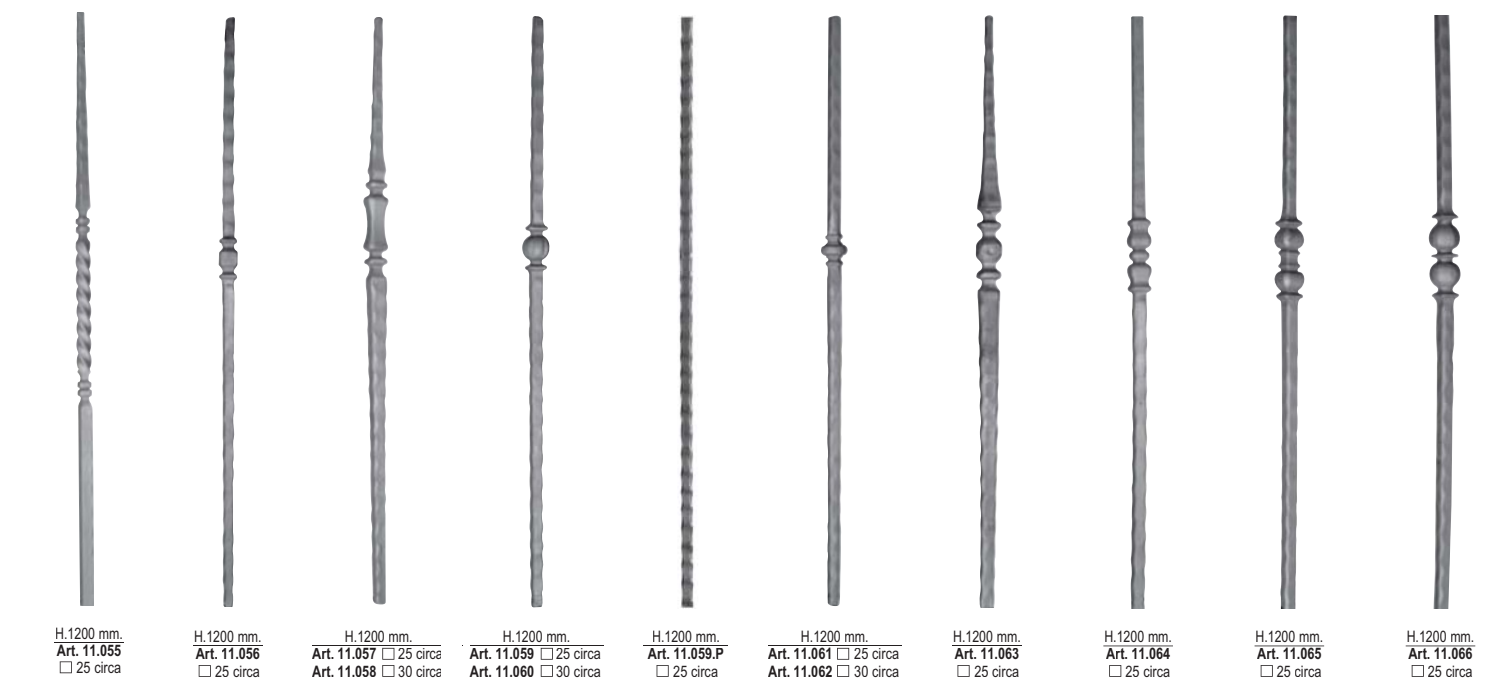
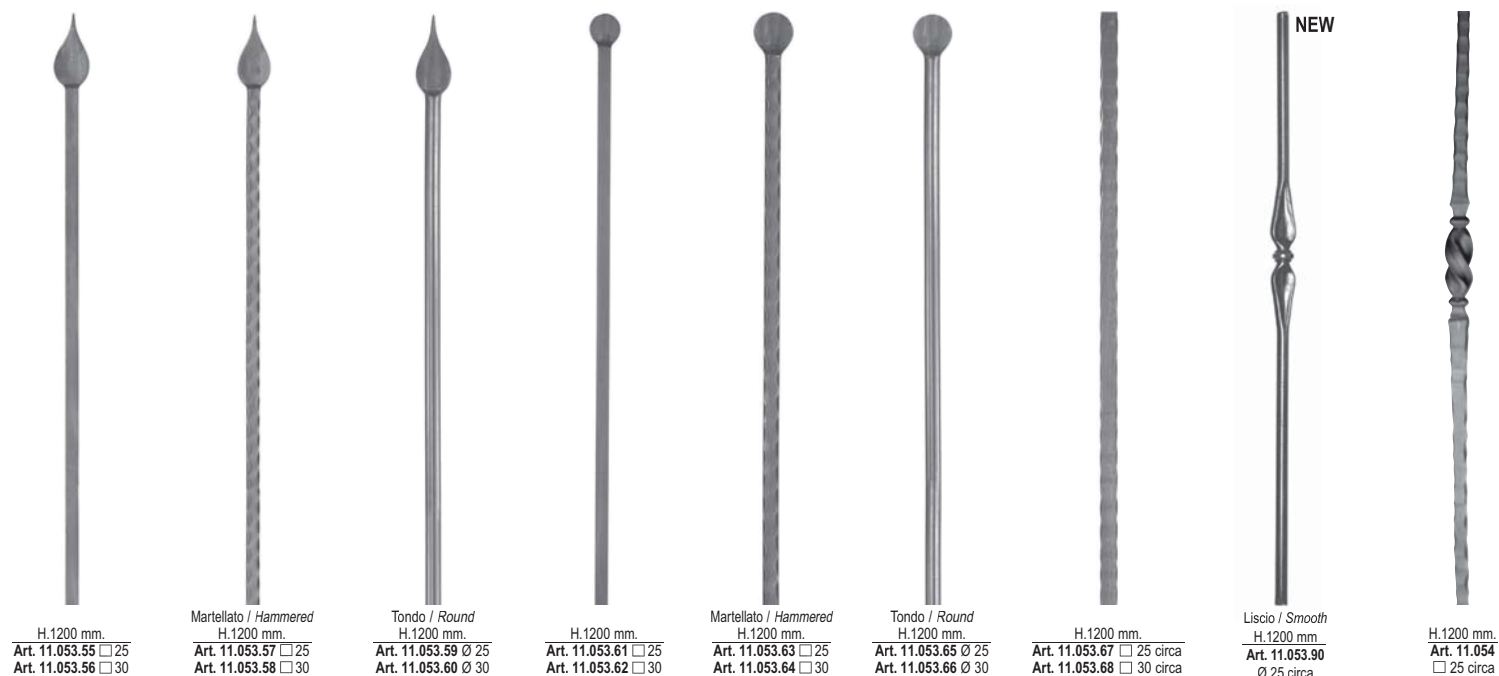
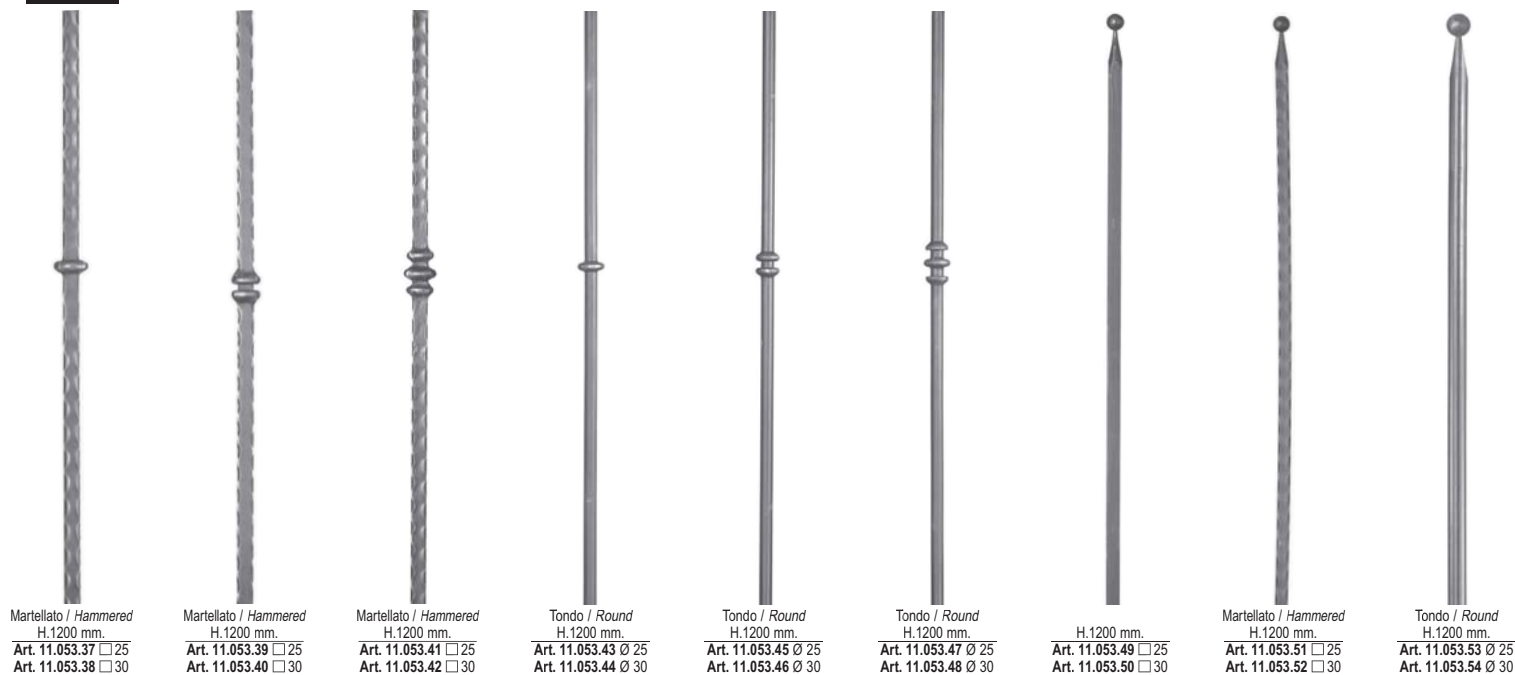

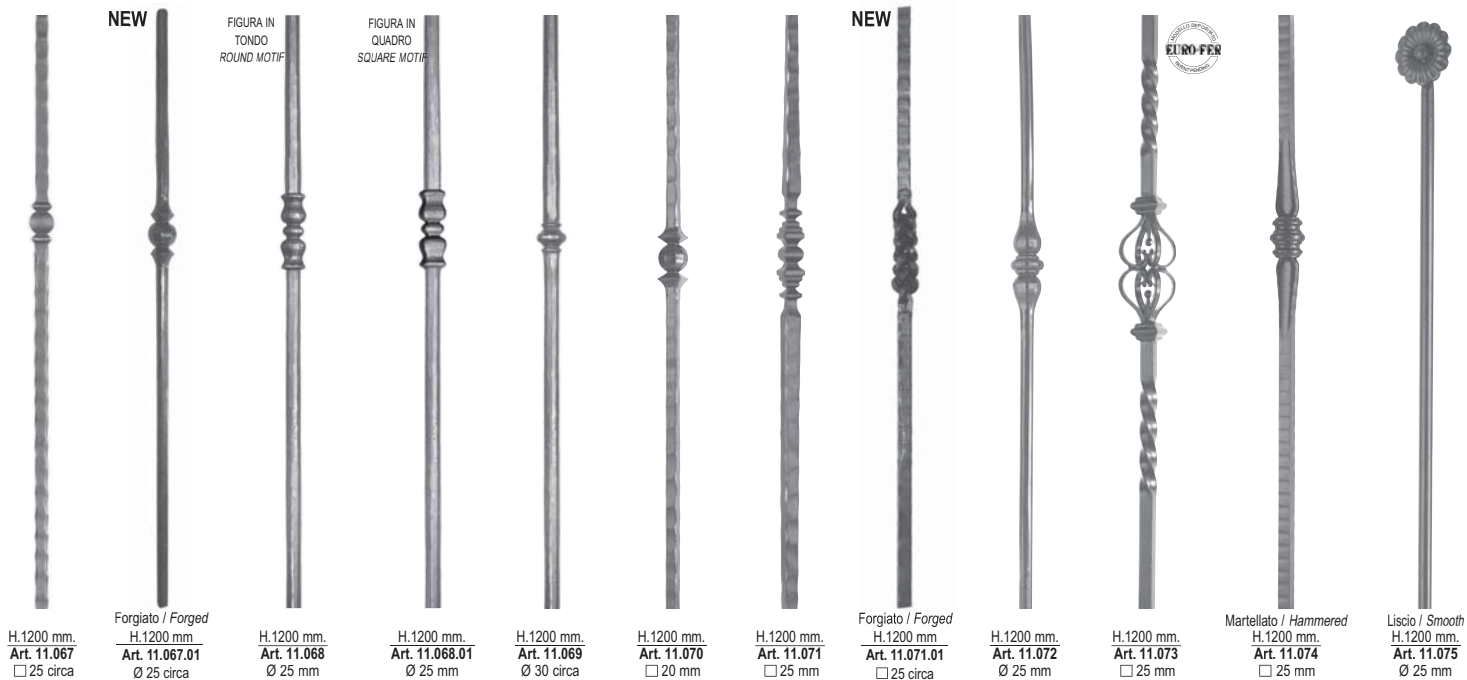

Tondo Lavorato / Round Hammered
H.1100 X L.400 mm.
Art. 11.077
Ø 30 mm



H.870 X L.480 mm.
Art. 11.078



H.970 X L.420 mm.
Art. 11.079



H.1100 x L.480 mm
Art. 11.080

NEW



Forgiato / Forged
L.3000 mm
Art. 11.200 □ 12 circa
Art. 11.201 □ 14 circa

NEW



Forgiato / Forged
L.3000 mm
Art. 11.210 □ 12 circa
Art. 11.211 □ 14 circa



H.160 mm.
Art. 11.100
□ 14 mm circa



H.160 mm.
Art. 11.101
□ 14 mm circa



H.160 mm.
Art. 11.102
□ 12 mm circa



H.200 mm.
Art. 11.150
□ 24 mm circa

La riproduzione, anche se solo parziale, del presente catalogo, è vietata.
Total or partial reproduction of this catalogue is not permitted.